

RF WIREWOUND CHIP INDUCTORS

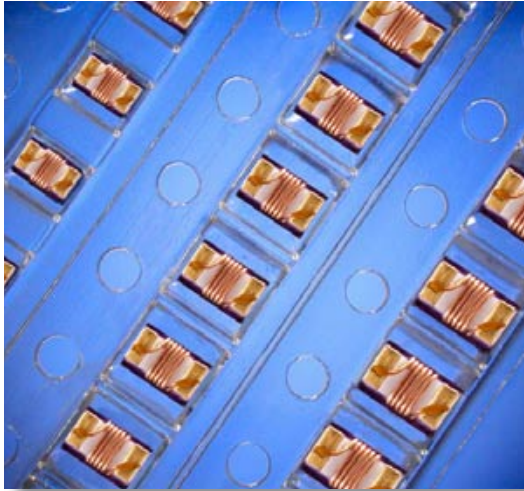

These high frequency High-Q chip inductors feature a monolithic body made of low loss ceramic wound with wire to achieve optimal high frequency performance.

These RF chip inductors are compact in size and are provided on tape and reel packaging which makes them ideal for high volume RF applications. They feature a nickel barrier with a top plating of gold for the ceramic core types (all 0402, all 0603, and most 0805 types), and with a top plating of 100% tin for the ferrite core types (0805 size, 470 nH and higher). Most inductance values between those listed are available on request.

APPLICATIONS

- CELL/PCS Modules
- Wireless LAN
- Broadband Components
- RFID
- RF Transceivers
- Cordless Phone
- Cable Modem
- Computer Peripherals
- Bluetooth
- ASDL

PRODUCT RANGE SUMMARY

EIA SIZE (mm)	SIZE CODE	L RANGE	Q FACTOR (Typ.)	SRF (Typ.)	TEMPERATURE
0402 (1005)	L-07	1.0 - 120 nH	55 (900 MHz)	>11 GHz (1.0 nH)	-40°C to + 125°C
0603 (1608)	L-14	2.0 - 470 nH	60 (900 MHz)	>13 GHz (2.0 nH)	-40°C to + 125°C
0805 (2012)	L-15	2.2 - 10,000 nH	60 (500 MHz)	>11 GHz (2.2 nH)	-40°C to + 125°C*

*-40 deg. C to +85 deg. C for ferrite core types

MECHANICAL CHARACTERISTICS

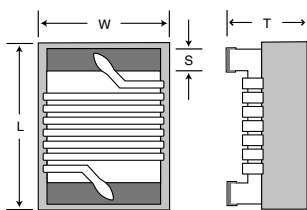

	0402 (1005)		0603 (1608)		0805 (2012)	
	Inches	mm	Inches	mm	Inches	mm
Length	.039 ±.004"	(1.00 ±.10)	.063 ±.008"	(1.60 ±.20)	.079 ±.008"	(2.00 ±.20)
Width	.022 ±.004"	(0.55 ±.10)	.041 ±.008"	(1.05 ±.20)	.049 ±.008"	(1.25 ±.20)
Thickness	.020 ±.004"	(0.50 ±.10)	.041 ±.008"	(1.05 ±.20)	.047 ±.008"	(1.20 ±.20)
End Band	.008 ±.004"	(0.20 ±.10)	.014 ±.004"	(0.35 ±.10)	.016 ±.004"	(0.40 ±.10)

HOW TO ORDER

L-	07	W	4N3	S	V	4	T
DEVICE	SIZE	TYPE	VALUE	TOLERANCE*	TERMINATION	MARKING	TAPE & REEL
Inductor	07 = 0402 14 = 0603 15 = 0805	W = Wirewound on Ceramic Core F = Wirewound on Ferrite Core	See Table	C = ± 0.2 nH S = ± 0.3 nH G = ± 2% J = ± 5% K = ± 10%	V = Ni / Au for "W" types, and V = Ni / 100% Sn for "F" types	4 = No Marking	Size Code Tape Reel Qty 0402 T Paper 7" 10,000 0603 E Embossed 7" 3,000 0805 E Embossed 7" 2,000

Example Part Number:

L-07W4N3SV4T is: 0402 Wirewound, 4.3 nanohenry, +/- 0.3 nH tolerance, Ni / Au termination, No Marking, Paper tape on a 7" reel.

* See selection chart on the following pages for available tolerances of each value.

0402 INDUCTANCE RANGE / ELECTRICAL CHARACTERISTICS

Part Number (Standard Tol.)	Inductance @250Mhz	Available Tolerances @250Mhz	Q (min.) @250Mhz	Q (Typ.) @900Mhz	Q (Typ.) @1.8Ghz	SRF (min.)	DC Resistance (max.)	Rated Current (max.)
L-07W1N0SV4T	1.0 nH	±0.2 nH, ±0.3 nH	13	49	60	6.0 Ghz	0.045 Ω	1360 mA
L-07W1N2SV4T	1.2 nH	±0.2 nH, ±0.3 nH	13	49	60	6.0 Ghz	0.060 Ω	1300 mA
L-07W1N8SV4T	1.8 nH	±0.2 nH, ±0.3 nH	16	50	60	6.0 Ghz	0.070 Ω	1040 mA
L-07W1N9SV4T	1.9 nH	±0.2 nH, ±0.3 nH	16	50	60	6.0 Ghz	0.070 Ω	1040 mA
L-07W2N0SV4T	2.0 nH	±0.2 nH, ±0.3 nH	16	51	62	6.0 Ghz	0.070 Ω	1040 mA
L-07W2N2SV4T	2.2 nH	±0.2 nH, ±0.3 nH	18	52	65	6.0 Ghz	0.070 Ω	960 mA
L-07W2N4SV4T	2.4 nH	±0.2 nH, ±0.3 nH	15	52	65	6.0 Ghz	0.068 Ω	790 mA
L-07W2N6SV4T	2.6 nH	±0.2 nH, ±0.3 nH	15	51	65	6.0 Ghz	0.120 Ω	640 mA
L-07W2N7SV4T	2.7 nH	±0.2 nH, ±0.3 nH	16	50	65	6.0 Ghz	0.120 Ω	640 mA
L-07W3N3JV4T	3.3 nH	±0.2 nH, ± 5%, ±10%	19	53	72	6.0 Ghz	0.066 Ω	840 mA
L-07W3N6JV4T	3.6 nH	±0.2 nH, ± 5%, ±10%	19	55	76	6.0 Ghz	0.066 Ω	840 mA
L-07W3N9JV4T	3.9 nH	±0.2 nH, ± 5%, ±10%	19	60	82	5.8 Ghz	0.066 Ω	840 mA
L-07W4N3JV4T	4.3 nH	±0.2 nH, ± 5%, ±10%	18	55	82	6.0 Ghz	0.091 Ω	700 mA
L-07W4N7JV4T	4.7 nH	±0.2 nH, ± 5%, ±10%	15	55	82	4.8 Ghz	0.130 Ω	640 mA
L-07W5N1JV4T	5.1 nH	±0.2 nH, ± 5%, ±10%	20	58	83	5.8 Ghz	0.083 Ω	800 mA
L-07W5N6JV4T	5.6 nH	±0.2 nH, ± 5%, ±10%	20	61	89	5.8 Ghz	0.083 Ω	760 mA
L-07W6N2JV4T	6.2 nH	±0.2 nH, ± 5%, ±10%	20	57	80	5.8 Ghz	0.083 Ω	760 mA
L-07W6N8JV4T	6.8 nH	±0.2 nH, ± 5%, ±10%	20	58	80	4.8 Ghz	0.083 Ω	680 mA
L-07W7N5JV4T	7.5 nH	±0.2 nH, ± 5%, ±10%	22	59	90	5.8 Ghz	0.104 Ω	680 mA
L-07W8N2JV4T	8.2 nH	±0.2 nH, ± 5%, ±10%	22	60	87	4.4 Ghz	0.104 Ω	680 mA
L-07W8N7JV4T	8.7 nH	±0.2 nH, ± 5%, ±10%	18	60	83	4.1 Ghz	0.200 Ω	480 mA
L-07W9N0JV4T	9.0 nH	±0.2 nH, ± 5%, ±10%	22	60	83	4.2 Ghz	0.104 Ω	680 mA
L-07W9N5JV4T	9.5 nH	±0.2 nH, ± 5%, ±10%	18	55	76	4.0 Ghz	0.200 Ω	680 mA
L-07W10NJV4T	10.0 nH	±2%, ± 5%, ±10%	21	56	76	3.9 Ghz	0.195 Ω	480 mA
L-07W11NJV4T	11.0 nH	±2%, ± 5%, ±10%	24	61	86	3.7 Ghz	0.120 Ω	640 mA
L-07W12NJV4T	12.0 nH	±2%, ± 5%, ±10%	24	58	77	3.6 Ghz	0.120 Ω	640 mA
L-07W13NJV4T	13.0 nH	±2%, ± 5%, ±10%	24	60	77	3.5 Ghz	0.210 Ω	560 mA
L-07W15NJV4T	15.0 nH	±2%, ± 5%, ±10%	24	61	86	3.3 Ghz	0.172 Ω	560 mA
L-07W16NJV4T	16.0 nH	±2%, ± 5%, ±10%	24	58	77	3.1 Ghz	0.220 Ω	560 mA
L-07W18NJV4T	18.0 nH	±2%, ± 5%, ±10%	24	58	77	3.1 Ghz	0.230 Ω	420 mA
L-07W19NJV4T	19.0 nH	±2%, ± 5%, ±10%	24	58	77	3.0 Ghz	0.202 Ω	480 mA
L-07W20NJV4T	20.0 nH	±2%, ± 5%, ±10%	24	54	74	3.0 Ghz	0.250 Ω	420 mA
L-07W22NJV4T	22.0 nH	±2%, ± 5%, ±10%	24	54	73	2.7 Ghz	0.300 Ω	400 mA
L-07W23NJV4T	23.0 nH	±2%, ± 5%, ±10%	24	55	73	2.7 Ghz	0.214 Ω	400 mA
L-07W24NJV4T	24.0 nH	±2%, ± 5%, ±10%	24	54	74	2.7 Ghz	0.300 Ω	400 mA
L-07W27NJV4T	27.0 nH	±2%, ± 5%, ±10%	24	55	75	2.5 Ghz	0.298 Ω	400 mA
L-07W30NJV4T	30.0 nH	±2%, ± 5%, ±10%	24	52	64	2.3 Ghz	0.300 Ω	400 mA
L-07W33NJV4T	33.0 nH	±2%, ± 5%, ±10%	24	52	64	2.3 Ghz	0.350 Ω	400 mA
L-07W36NJV4T	36.0 nH	±2%, ± 5%, ±10%	24	52	64	2.3 Ghz	0.403 Ω	320 mA
L-07W39NJV4T	39.0 nH	±2%, ± 5%, ±10%	24	51	48	2.1 Ghz	0.550 Ω	320 mA
L-07W40NJV4T	40.0 nH	±2%, ± 5%, ±10%	24	51	48	2.3 Ghz	0.438 Ω	320 mA
L-07W43NJV4T	43.0 nH	±2%, ± 5%, ±10%	24	50	46	2.0 Ghz	0.810 Ω	100 mA
L-07W47NJV4T	47.0 nH	±2%, ± 5%, ±10%	22*	50	46	2.1 Ghz	0.830 Ω	100 mA
L-07W51NJV4T	51.0 nH	+/- 5%, +/- 10%	22*	49	N/A	1.7 Ghz	0.820 Ω	100 mA
L-07W56NJV4T	56.0 nH	+/- 5%, +/- 10%	22*	49	N/A	1.7 Ghz	0.970 Ω	100 mA
L-07W68NJV4T	68.0 nH	+/- 5%, +/- 10%	22*	42	N/A	1.6 Ghz	1.120 Ω	100 mA
L-07W82NJV4T	82.0 nH	+/- 5%, +/- 10%	16**	39	N/A	1.5 Ghz	1.250 Ω	100 mA
L-07WR10JV4T	100.0 nH	+/- 5%, +/- 10%	16**	36	N/A	1.3 Ghz	2.520 Ω	100 mA
L-07WR11JV4T	110.0 nH	+/- 5%, +/- 10%	14**	35	N/A	1.2 GHz	2.600 Ω	100 mA
L-07WR12JV4T	120.0 nH	+/- 5%, +/- 10%	14**	35	N/A	1.1 Ghz	2.660 Ω	100 mA

* 200 Mhz

** 150 MHz

NOTE: Most inductance values between those listed above are available on request.

Rated current shown is for 15 degrees C rise

0603 INDUCTANCE RANGE / ELECTRICAL CHARACTERISTICS

Part Number (Standard Tol.)	Inductance @ L/Q Freq.	L/Q Test Freq.	Available Tolerances @L/Q Freq.	Q (min.) @L/Q Freq	SRF (min.)	DC Resistance (max.)	Rated Current (max.)
L-14W1N6SV4E	1.6 nH	250 Mhz	±0.2 nH, ±0.3 nH	14	7.0 GHz	0.080 Ω	700 mA
L-14W1N8SV4E	1.8 nH	250 MHz	±0.2 nH, ±0.3 nH	16	6.9 GHz	0.080 Ω	700 mA
L-14W2N0SV4E	2.0 nH	250 Mhz	±0.2 nH, ±0.3 nH	16	6.9 Ghz	0.080 Ω	700 mA
L-14W3N3SV4E	3.3 nH	250 MHz	±0.2 nH, ±0.3 nH	17	6.1 GHz	0.080 Ω	700 mA
L-14W3N6SV4E	3.6 nH	250 Mhz	±0.2 nH, ±0.3 nH	20	6.0 Ghz	0.080 Ω	700 mA
L-14W3N9SV4E	3.9 nH	250 Mhz	±0.2 nH, ±0.3 nH	22	5.9 Ghz	0.080 Ω	700 mA
L-14W4N3SV4E	4.3 nH	250 Mhz	±0.2 nH, ±0.3 nH	22	5.8 Ghz	0.060 Ω	700 mA
L-14W4N7SV4E	4.7 nH	250 Mhz	±0.2 nH, ±0.3 nH	20	5.8 Ghz	0.110 Ω	700 mA
L-14W5N1JV4E	5.1 nH	250 Mhz	±0.2 nH, ± 5%, ±10%	18	5.4 Ghz	0.110 Ω	700 mA
L-14W5N6JV4E	5.6 nH	250 MHz	±0.2 nH, ± 5%, ±10%	16	5.0 GHz	0.110 Ω	700 mA
L-14W6N8JV4E	6.8 nH	250 Mhz	±0.2 nH, ± 5%, ±10%	30	4.6 Ghz	0.110 Ω	700 mA
L-14W7R5JV4E	7.5 nH	250 MHz	±0.2 nH, ± 5%, ±10%	30	4.7 GHz	0.110 Ω	700 mA
L-14W8N2JV4E	8.2 nH	250 Mhz	±0.2 nH, ± 5%, ±10%	30	4.8 Ghz	0.100 Ω	700 mA
L-14W8N7JV4E	8.7 nH	250 Mhz	±2%, ± 5%, ±10%	30	4.6 Ghz	0.120 Ω	700 mA
L-14W10NJV4E	10.0 nH	250 Mhz	±2%, ± 5%, ±10%	31	4.0 Ghz	0.130 Ω	700 mA
L-14W11NJV4E	11.0 nH	250 MHz	±2%, ± 5%, ±10%	33	4.0 GHz	0.086 Ω	700 mA
L-14W12NJV4E	12.0 nH	250 Mhz	±2%, ± 5%, ±10%	35	4.0 Ghz	0.130 Ω	700 mA
L-14W15NJV4E	15.0 nH	250 MHz	±2%, ± 5%, ±10%	35	3.1 Ghz	0.170 Ω	700 mA
L-14W18NJV4E	18.0 nH	250 Mhz	±2%, ± 5%, ±10%	38	3.0 Ghz	0.170 Ω	700 mA
L-14W22NJV4E	22.0 nH	250 Mhz	±2%, ± 5%, ±10%	38	3.0 Ghz	0.220 Ω	700 mA
L-14W27NJV4E	27.0 nH	250 Mhz	±2%, ± 5%, ±10%	40	2.8 Ghz	0.220 Ω	600 mA
L-14W33NJV4E	33.0 nH	250 Mhz	±2%, ± 5%, ±10%	43	2.3 Ghz	0.220 Ω	600 mA
L-14W39NJV4E	39.0 nH	250 Mhz	±2%, ± 5%, ±10%	43	2.2 Ghz	0.250 Ω	600 mA
L-14W47NJV4E	47.0 nH	200 Mhz	±2%, ± 5%, ±10%	40	2.0 Ghz	0.280 Ω	600 mA
L-14W51NJV4E	51.0 nH	200 Mhz	±2%, ± 5%, ±10%	40	1.9 Ghz	0.300 Ω	600 mA
L-14W56NJV4E	56.0 nH	200 Mhz	±2%, ± 5%, ±10%	40	1.9 Ghz	0.310 Ω	600 mA
L-14W68NJV4E	68.0 nH	200 Mhz	±2%, ± 5%, ±10%	40	1.7 Ghz	0.340 Ω	600 mA
L-14W72NJV4E	72.0 nH	150 Mhz	±2%, ± 5%, ±10%	35	1.7 Ghz	0.490 Ω	400 mA
L-14W82NJV4E	82.0 nH	150 Mhz	±2%, ± 5%, ±10%	35	1.7 Ghz	0.540 Ω	400 mA
L-14WR10JV4E	100.0 nH	150 Mhz	±2%, ± 5%, ±10%	35	1.4 Ghz	0.630 Ω	400 mA
L-14WR12JV4E	120.0 nH	150 Mhz	±2%, ± 5%, ±10%	35	1.3 Ghz	0.650 Ω	300 mA
L-14WR15JV4E	150.0 nH	150 Mhz	±2%, ± 5%, ±10%	35	1.0 Ghz	0.920 Ω	280 mA
L-14WR18JV4E	180.0 nH	100 Mhz	±2%, ± 5%, ±10%	30	1.0 Ghz	1.25 Ω	240 mA
L-14WR22JV4E	220.0 nH	100 Mhz	±2%, ± 5%, ±10%	30	1.0 Ghz	1.70 Ω	200 mA
L-14WR27JV4E	270.0 nH	100 Mhz	±2%, ± 5%, ±10%	30	1.0 Ghz	1.80 Ω	170 mA
L-14WR33JV4E	330.0 nH	100 MHz	± 5%, ±10%	25	900 MHz	3.60 Ω	150 mA
L-14WR39JV4E	390.0 nH	100 MHz	± 5%, ±10%	24	750 MHz	5.30 Ω	100 mA
L-14WR47JV4E	470.0 nH	100 MHz	± 5%, ±10%	23	700 MHz	5.60 Ω	100 mA

Parts shown are for one tolerance only. Tolerances available are as shown in the "Tolerance" column.

NOTE: Most inductance values between those listed above are available on request.

Rated current shown is for 15 degrees C rise



0805 INDUCTANCE RANGE / ELECTRICAL CHARACTERISTICS

Part Number (Standard Tol.)	Inductance @L Test Freq.	L Test Freq.	Available Tolerances @L Test Freq.	Q (min.) @Q Test Freq.	Q Test Freq.	SRF (min.)	DC Resistance (max.)	Rated Current (max.)
L-15W2N2SV4E	2.2 nH	250 Mhz	±0.2 nH, ±0.3 nH	50	1000 Mhz	>6000 Mhz	0.06 Ω	800 mA
L-15W2N7SV4E	2.7 nH	250 Mhz	±0.2 nH, ±0.3 nH	35	1000 Mhz	>6000 Mhz	0.08 Ω	800 mA
L-15W3N3SV4E	3.3 nH	250 Mhz	±0.2 nH, ±0.3 nH	60	1000 Mhz	>6000 Mhz	0.08 Ω	800 mA
L-15W3N9SV4E	3.9 nH	250 Mhz	±0.2 nH, ±0.3 nH	60	1000 Mhz	>6000 Mhz	0.06 Ω	600 mA
L-15W4N7SV4E	4.7 nH	250 Mhz	±0.2 nH, ±0.3 nH	60	1000 Mhz	5800 Mhz	0.06 Ω	600 mA
L-15W5N6JV4E	5.6 nH	250 Mhz	±0.2 nH, ± 5%, ±10%	60	1000 Mhz	5800 Mhz	0.08 Ω	600 mA
L-15W6N8JV4E	6.8 nH	250 Mhz	±0.2 nH, ± 5%, ±10%	60	1000 Mhz	5500 Mhz	0.06 Ω	600 mA
L-15W8N2JV4E	8.2 nH	250 Mhz	±0.2 nH, ± 5%, ±10%	60	1000 Mhz	5500 Mhz	0.06 Ω	600 mA
L-15W10NJV4E	10.0 nH	250 Mhz	±2%, ± 5%, ±10%	60	500 Mhz	4800 Mhz	0.08 Ω	600 mA
L-15W12NJV4E	12.0 nH	250 Mhz	±2%, ± 5%, ±10%	60	500 Mhz	4100 Mhz	0.08 Ω	600 mA
L-15W15NJV4E	15.0 nH	250 Mhz	±2%, ± 5%, ±10%	60	500 Mhz	3600 Mhz	0.08 Ω	600 mA
L-15W16NJV4E	16.0 nH	250 Mhz	±2%, ± 5%, ±10%	60	500 Mhz	3500 Mhz	0.08 Ω	600 mA
L-15W18NJV4E	18.0 nH	250 Mhz	±2%, ± 5%, ±10%	60	500 Mhz	3400 Mhz	0.08 Ω	600 mA
L-15W20NJV4E	20.0 nH	250 Mhz	±2%, ± 5%, ±10%	60	500 Mhz	3400 Mhz	0.08 Ω	600 mA
L-15W22NJV4E	22.0 nH	250 Mhz	±2%, ± 5%, ±10%	60	500 Mhz	3300 Mhz	0.10 Ω	600 mA
L-15W27NJV4E	27.0 nH	250 Mhz	±2%, ± 5%, ±10%	60	500 Mhz	2600 Mhz	0.12 Ω	600 mA
L-15W33NJV4E	33.0 nH	250 Mhz	±2%, ± 5%, ±10%	60	500 Mhz	2400 Mhz	0.15 Ω	500 mA
L-15W39NJV4E	39.0 nH	250 Mhz	±2%, ± 5%, ±10%	60	500 Mhz	2100 Mhz	0.18 Ω	500 mA
L-15W47NJV4E	47.0 nH	200 Mhz	±2%, ± 5%, ±10%	60	500 Mhz	1700 Mhz	0.15 Ω	500 mA
L-15W56NJV4E	56.0 nH	200 Mhz	±2%, ± 5%, ±10%	60	500 Mhz	1600 Mhz	0.25 Ω	500 mA
L-15W68NJV4E	68.0 nH	200 Mhz	±2%, ± 5%, ±10%	60	500 Mhz	1450 Mhz	0.27 Ω	500 mA
L-15W82NJV4E	82.0 nH	150 Mhz	±2%, ± 5%, ±10%	60	500 Mhz	1350 Mhz	0.32 Ω	500 mA
L-15WR10JV4E	100 nH	150 Mhz	±2%, ± 5%, ±10%	57	250 Mhz	1200 Mhz	0.43 Ω	500 mA
L-15WR12JV4E	120 nH	150 Mhz	±2%, ± 5%, ±10%	50	250 Mhz	1100 Mhz	0.48 Ω	500 mA
L-15WR15JV4E	150 nH	100 Mhz	±2%, ± 5%, ±10%	50	250 Mhz	950 Mhz	0.56 Ω	400 mA
L-15WR18JV4E	180 nH	100 Mhz	±2%, ± 5%, ±10%	50	250 Mhz	900 Mhz	0.78 Ω	400 mA
L-15WR22JV4E	220 nH	100 Mhz	±2%, ± 5%, ±10%	50	250 Mhz	860 Mhz	1.00 Ω	400 mA
L-15WR27JV4E	270 nH	100 Mhz	±2%, ± 5%, ±10%	45	250 Mhz	850 Mhz	1.46 Ω	350 mA
L-15WR33JV4E	330 nH	100 Mhz	±2%, ± 5%, ±10%	45	250 Mhz	800 Mhz	1.65 Ω	300 mA
L-15WR39JV4E	390 nH	100 Mhz	±2%, ± 5%, ±10%	45	250 Mhz	780 Mhz	2.20 Ω	210 mA
L-15FR47JV4E	470 nH	25 Mhz	± 5%, ±10%	45	100 Mhz	375 Mhz	0.95 Ω	500 mA
L-15FR56JV4E	560 nH	25 Mhz	± 5%, ±10%	45	100 Mhz	340 Mhz	1.10 Ω	450 mA
L-15FR68JV4E	680 nH	25 Mhz	± 5%, ±10%	35	100 Mhz	188 Mhz	1.20 Ω	400 mA
L-15FR82JV4E	820 nH	25 Mhz	± 5%, ±10%	35	100 Mhz	215 Mhz	1.50 Ω	300 mA
L-15F1R0JV4E	1000 nH	25 Mhz	± 5%, ±10%	35	50 Mhz	200 Mhz	2.13 Ω	180 mA
L-15F1R2JV4E	1200 nH	8 Mhz	± 5%, ±10%	15	8 Mhz	200 Mhz	2.38 Ω	150 mA
L-15F1R5JV4E	1500 nH	8 Mhz	± 5%, ±10%	15	8 Mhz	200 Mhz	2.90 Ω	130 mA
L-15F1R8JV4E	1800 nH	8 Mhz	± 5%, ±10%	15	8 Mhz	120 Mhz	3.00 Ω	120 mA
L-15F2R2JV4E	2200 nH	8 Mhz	± 5%, ±10%	15	8 Mhz	110 Mhz	3.10 Ω	110 mA
L-15F2R7JV4E	2700 nH	8 Mhz	± 5%, ±10%	15	8 Mhz	100 Mhz	3.50 Ω	100 mA
L-15F3R3JV4E	3300 nH	8 Mhz	± 5%, ±10%	15	8 Mhz	70 Mhz	2.30 Ω	210 mA
L-15F3R9JV4E	3900 nH	8 Mhz	± 5%, ±10%	15	8 Mhz	60 Mhz	2.50 Ω	200 mA
L-15F4R7JV4E	4700 nH	8 Mhz	± 5%, ±10%	15	8 Mhz	50 Mhz	2.80 Ω	180 mA
L-15F5R6JV4E	5600 nH	8 Mhz	± 5%, ±10%	15	8 Mhz	45 Mhz	3.00 Ω	160 mA
L-15F6R8JV4E	6800 nH	8 Mhz	± 5%, ±10%	15	8 Mhz	45 Mhz	3.20 Ω	130 mA
L-15F8R2JV4E	8200 nH	8 Mhz	± 5%, ±10%	15	8 Mhz	40 Mhz	3.50 Ω	120 mA
L-15F10RJV4E	10000 nH	8 Mhz	± 5%, ±10%	10	8 Mhz	40 Mhz	5.00 Ω	80 mA

Parts shown are for one tolerance only. Tolerances available are as shown in the "Tolerance" column.

NOTE: Most inductance values between those listed above are available on request.

Rated current shown is for 15 degrees C rise



RF CHARACTERISTICS CHARACTERISTICS (TYPICAL)

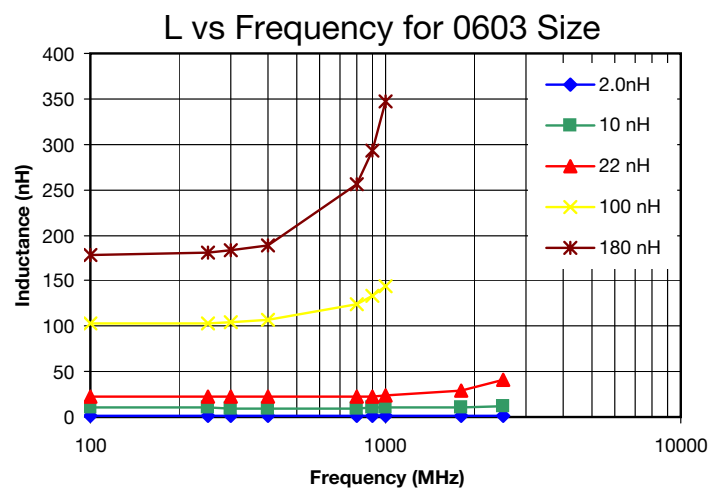
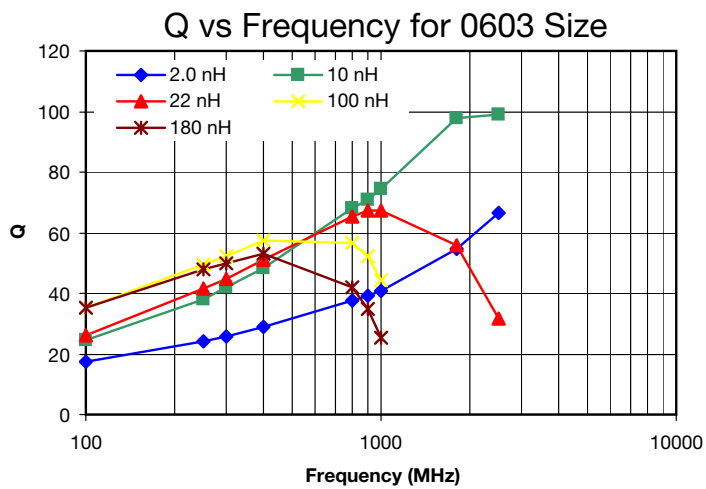
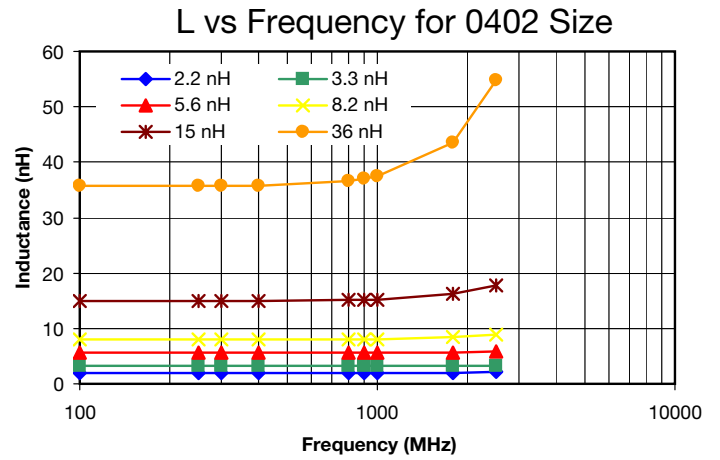
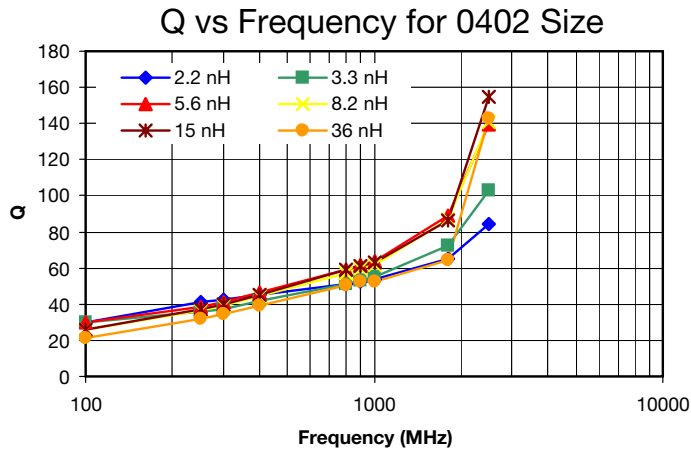

Q / ESR measured with an Agilent 4287A Impedance Analyzer and a 16193A fixture.
 SRF measured with a HP 8720C Vector Network Analyzer using a Series-Through fixture.

MECHANICAL & ENVIRONMENTAL CHARACTERISTICS

	SPECIFICATION	TEST PARAMETERS
OPERATING TEMPERATURE RANGE	Ceramic core: -40°C to +125°C Ferrite core: -40°C to +85°C	
COEFFICIENT OF EXPANSION	Ceramic Core: 7.2×10^{-6} / deg. C (typ.) Ferrite Core: 10×10^{-6} / deg. C (typ.)	
INDUCTANCE AND TOLERANCE	Within Specified Tolerance	Measuring Frequency : As shown in Product Table Measuring Temperature : + 25 °C
QUALITY FACTOR	Within Specified Tolerance	Measuring Frequency : As shown in Product Table Measuring Temperature : + 25 °C
INSULATION RESISTANCE	1000 mega ohms minimum	Measured at 100V DC between inductor terminals and center of case.
DIELECTRIC WITHSTANDING VOLTAGE	No damage occurs when the test voltage is applied.	Measured at 500V AC between inductor terminals and center of case for a maximum of 1 minute.
TEMPERATURE COEFFICIENT OF INDUCTANCE (TCL)	Ceramic Core: +25 to +125 ppm / °C Ferrite Core: +25 to +500 ppm / °C $TCL = \frac{L1 - L2}{L1(T1-T2)} \times 10^6 \text{ (ppm / °C)}$	Over - 40 °C to + 85°C at frequency specified in Product Table.
COMPONENT ADHESION (PUSH TEST)	0402 series - 350g 0603 series - 1.0Kg 0805 series - Minimum 2Kg for ceramic core parts and 1 Kg for ferrite core parts.	The component shall be reflow soldered onto a P. C. Board (230 °C ± 5°C for 20 seconds). Then a dynamometer force gauge shall be applied to any side of the component.
DROP TEST	Change In Inductance: No more than 5% Change In Q: No more than 10% Change In Appearance: Without distinct damage	The inductor shall be dropped two times on a concrete floor or a vinyl tile from a 1 meter height.
THERMAL SHOCK TEST	Change In Inductance: No more than 5% Change In Q: No more than 10% Change In Appearance: Without distinct damage	Each cycle shall consist of 30 minutes at -40 °C followed by 30 minutes at +85 °C with a 20-second maximum transition time between temperature extremes. Test duration is 10 cycles.

MECHANICAL & ENVIRONMENTAL CHARACTERISTICS

	SPECIFICATION	TEST PARAMETERS
SOLDERABILITY	A minimum of 80% of the metalized area must be covered with solder.	Dip pads in flux and dip in solder pot (63Sn / 37Pb) at 230 °C ± 5°C for 5 seconds.
RESISTANCE TO SOLDERING HEAT	Change In Inductance: No more than 5% Change In Q: No more than 10% Change in Appearance: Without distinct damage	Dip the components into flux and dip into solder pot containing 63Sn / 37Pb at 260 °C ± 5 °C for 5 ± 2 seconds.
VIBRATION (RANDOM)	Change In Inductance: No more than 5% Change In Q: No more than 10% Change in Appearance: Without distinct damage	Inductors shall be randomly vibrated at amplitude of 1.5mm and frequency of 10 - 55 Hz: 0.04 G / Hz for a minimum of 15 minutes per axis for each of the three axes.
COLD TEMPERATURE STORAGE	Change In Inductance: No more than 5% Change In Q: No more than 10% Change in Appearance: Without distinct damage	Inductors shall be stored at temperature of -40 °C ± 2 °C for 48 ± 2 hours. Then inductors shall be subjected to standard atmospheric conditions for 1 hour. After that, measurement shall be made.
HIGH TEMPERATURE STORAGE	Change In Inductance: No more than 5% Change In Q: No more than 10% Change in Appearance: Without distinct damage	Inductors shall be stored at temperature of 125 °C ± 2 °C for 48 ± 2 hours. Then inductors shall be subjected to standard atmospheric conditions for 1 hour. After that, measurement shall be made.
MOISTURE RESISTANCE	Inductors shall not have a shorted or open winding.	Inductors shall be stored in the chamber at 45 °C at 90 - 95 R. H. for 240 hours. Then inductors are to be tested after 2 hours at room temperature.
HIGH TEMPERATURE WITH LOADED	Inductors shall not have a shorted or open winding.	Inductors shall be stored in the chamber at +85 °C for 1000 hours with rated current applied. Inductors shall be tested at the beginning of test at 500 hours and 1000 hours. Then inductors are to be tested after 1 hour at room temperature.
STATIC HUMIDITY	Inductance must not change more than the stated tolerance.	Subjected to 85°C, 85% relative humidity for 100 hours. Inductors are to be tested after being air dried for two hours.
RESISTANCE TO SOLVENT	There must be no case deformation, change in dimensions, or obliteration of marking.	Must withstand 6 minutes of alcohol or water.

Packing Quantity

TYPE	PCS / REEL
L-07	10,000
L-14	3,000
L-15	2,000

Reel Dimensions

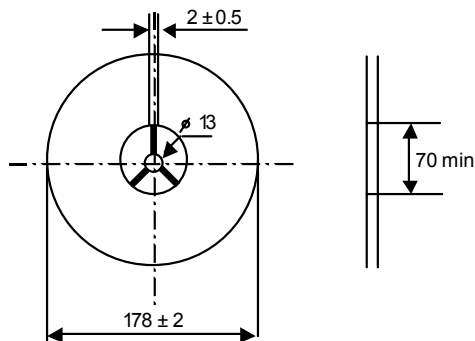

Dimensions (unit: m/m)

TYPE	A	B	T
L-07	0.70	1.20	0.70
L-14	1.25	1.80	1.20
L-15	1.42	2.26	1.40

Tape Dimensions

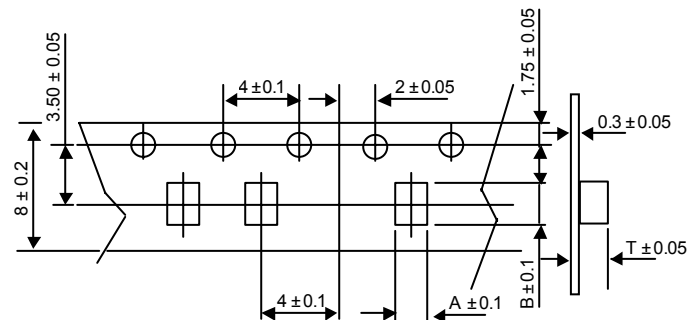

Dimensions (unit: m/m)

TYPE	A	B	C
L-07	1.20	0.45	0.65
L-14	1.90	0.65	1.00
L-15	2.60	0.75	1.20

Recommended Pattern

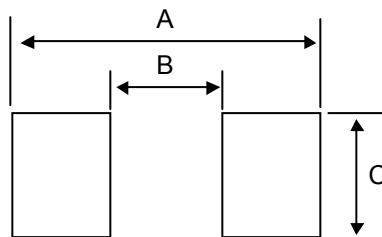

Remark:

- 1) Blank length: 160 mm minimum for loading.
- 2) Blank length: 80 mm minimum for unloading.